

Metal Oxide Varistor : TVB Series



Plastic Encapsulated Type Varistor for Surge Protection

■ Features

1. RoHS compliant
2. Available for IR-reflow soldering
3. Low profile and space saving
4. Large capability to withstand high surge current
5. Low inductance construction with excellent response
6. Encapsulation material according to UL94-V0
7. Electrical characteristics of TVBDS series and TVBES series are equivalent to leaded type TVR10 series and TVR14 series respectively.
8. Operating temperature range:
TVB7S Series/TVB9S Series: -40°C ~ +85°C
TVBDS Series/TVBES Series: -40°C ~ +105°C
9. Storage temperature range: -40°C ~ +125°C
10. Agency recognition:
TVB7S Series/TVB9S Series: UL/cUL/TUV
TVBDS Series/TVBES Series: UL/cUL/TUV/CQC



■ Recommended Applications

1. Power supply
2. Home appliance
3. Industrial equipment
4. Telecommunication or telephone system

■ Part Number Code

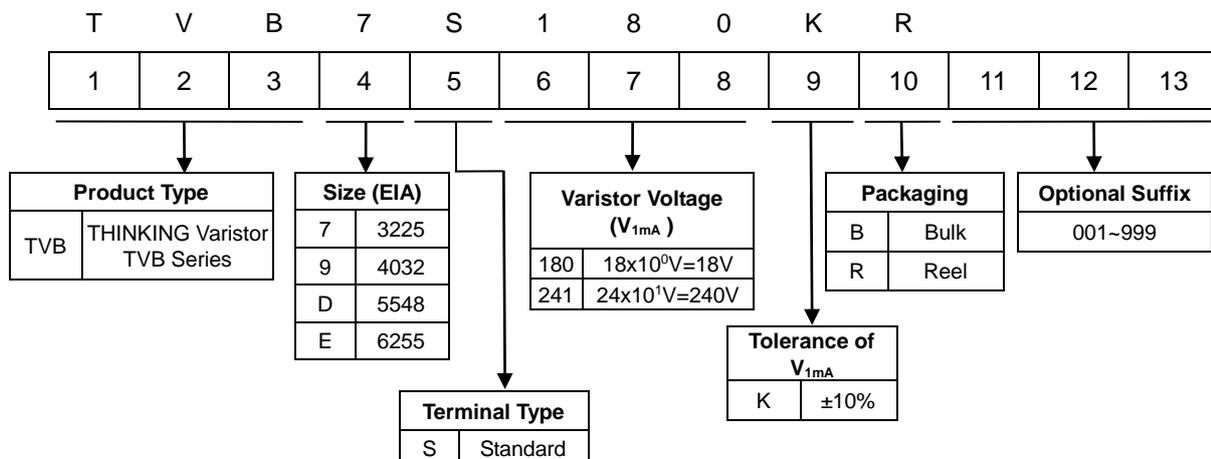

Metal Oxide Varistor : TVB Series



Plastic Encapsulated Type Varistor for Surge Protection

Structures and Dimensions

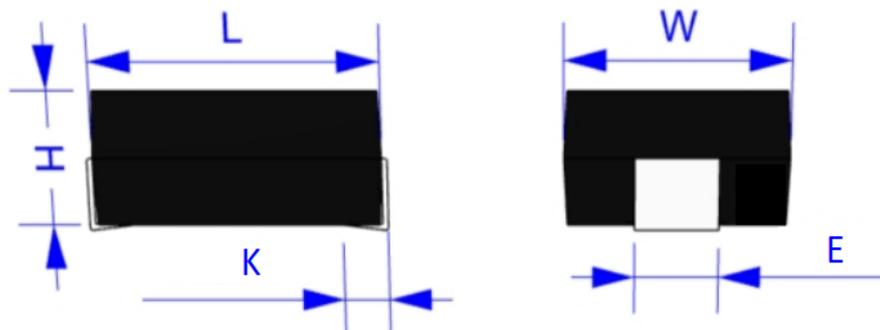

(Unit: mm)

Size (EIA)	Varistor Voltage Range (V)	L	W	H	K	E
3225	$V_{1mA}=180 \sim 271$	8.0 ± 0.3	6.3 ± 0.3	3.2 ± 0.3	1.5 ± 0.3	3 ± 0.3
	$V_{1mA}=361 \sim 561$			4.5 ± 0.3		
4032	$V_{1mA}=180 \sim 271$	10.5 ± 0.3	8.0 ± 0.3	3.2 ± 0.3	1.5 ± 0.3	3 ± 0.3
	$V_{1mA}=301 \sim 751$			4.5 ± 0.3		
5548	$V_{1mA}=270 \sim 361$	14.0 ± 0.3	12.2 ± 0.3	4.0 ± 0.3	2.0 ± 0.3	3.0 ± 0.3
	$V_{1mA}=391 \sim 751$			6.0 ± 0.3		
6225	$V_{1mA}=270 \sim 361$	15.8 ± 0.3	14.0 ± 0.3	4.0 ± 0.3	2.0 ± 0.3	4.0 ± 0.3
	$V_{1mA}=391 \sim 751$			6.0 ± 0.3		

Soldering Pads

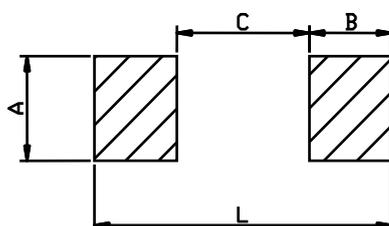

(Unit: mm)

Item	A	B	C	L	
Size (EIA)	3225	3.5	2.8	4.5	10.1
	4032	3.5	2.8	6.5	12.1
	5548	3.5	3.3	8.4	--
	6225	4.5	3.3	10.2	--

Metal Oxide Varistor : TVB Series



Plastic Encapsulated Type Varistor for Surge Protection

■ Electrical Characteristics

TVB7S Series (3225 Size)

Part No.	Varistor Voltage (@ 1mA DC)	Max. Continuous Voltage		Max. Clamping Voltage (8/20μs)		Max. Surge Current (8/20μs)	Max. Energy (10/1000μs)	Rated Power
	V _{1mA} (V)	V _{AC(rms)} (V)	V _{DC} (V)	V _P (V)	I _P (A)	I _{max} (A)	W _{max} (J)	P (W)
TVB7S180	18 (16~20)	11	14	36	1.0	150	0.6	0.01
TVB7S220	22 (20~24)	14	18	43	1.0	150	0.7	0.01
TVB7S270	27 (24~30)	17	22	53	1.0	150	0.9	0.01
TVB7S330	33 (30~36)	20	26	65	1.0	150	1.1	0.01
TVB7S390	39 (35~43)	25	31	77	1.0	150	1.2	0.01
TVB7S470	47 (42~52)	30	38	93	1.0	150	1.5	0.01
TVB7S560	56 (50~62)	35	45	110	1.0	150	1.8	0.01
TVB7S680	68 (61~75)	40	56	135	1.0	150	2.2	0.01
TVB7S820	82 (74~90)	50	65	135	5.0	400	2.5	0.1
TVB7S101	100 (90~110)	60	85	165	5.0	400	3.0	0.1
TVB7S121	120 (108~132)	75	100	200	5.0	400	4.0	0.1
TVB7S151	150 (135~165)	95	125	250	5.0	400	6.0	0.1
TVB7S181	180 (162~198)	115	150	300	5.0	400	6.5	0.1
TVB7S201	200 (180~220)	130	170	340	5.0	400	7.0	0.1
TVB7S221	220 (198~242)	140	180	360	5.0	400	7.5	0.1
TVB7S241	240 (216~264)	150	200	395	5.0	400	9.0	0.1
TVB7S271	270 (243~297)	175	225	455	5.0	400	9.5	0.1
TVB7S361	360 (324~396)	230	300	595	5.0	400	10.0	0.1
TVB7S391	390 (351~429)	250	320	650	5.0	400	11.0	0.1
TVB7S431	430 (387~473)	275	350	710	5.0	400	13.0	0.1
TVB7S471	470 (423~517)	300	385	775	5.0	400	15.0	0.1
TVB7S511	510 (459~561)	320	410	845	5.0	400	16.5	0.1
TVB7S561	560 (504~616)	350	450	930	5.0	400	18.0	0.1

Metal Oxide Varistor : TVB Series



Plastic Encapsulated Type Varistor for Surge Protection

TVB9S Series (4032 Size)

Part No.	Varistor Voltage (@ 1mA DC)	Max. Continuous Voltage		Max. Clamping Voltage (8/20μs)		Max. Surge Current (8/20μs)	Max. Energy (10/1000μs)	Rated Power
	V _{1mA} (V)	V _{AC(rms)} (V)	V _{DC} (V)	V _P (V)	I _P (A)	I _{max} (A)	W _{max} (J)	P (W)
TVB9S180	18 (16~20)	11	14	36	2.5	300	1.1	0.02
TVB9S220	22 (20~24)	14	18	43	2.5	300	1.3	0.02
TVB9S270	27 (24~30)	17	22	53	2.5	300	1.6	0.02
TVB9S330	33 (30~36)	20	26	65	2.5	300	2.0	0.02
TVB9S390	39 (35~43)	25	31	77	2.5	300	2.4	0.02
TVB9S470	47 (42~52)	30	38	93	2.5	300	2.8	0.02
TVB9S560	56 (50~62)	35	45	110	2.5	300	3.4	0.02
TVB9S680	68 (61~75)	40	56	135	2.5	300	4.1	0.02
TVB9S820	82 (74~90)	50	65	135	10	1200	6.5	0.25
TVB9S101	100 (90~110)	60	85	165	10	1200	7.0	0.25
TVB9S121	120 (108~132)	75	100	200	10	1200	9.0	0.25
TVB9S151	150 (135~165)	95	125	250	10	1200	11.0	0.25
TVB9S181	180 (162~198)	115	150	300	10	1200	13.0	0.25
TVB9S201	200 (180~220)	130	170	340	10	1200	15.0	0.25
TVB9S221	220 (198~242)	140	180	360	10	1200	18.0	0.25
TVB9S241	240 (216~264)	150	200	395	10	1200	18.5	0.25
TVB9S271	270 (243~297)	175	225	455	10	1200	21.0	0.25
TVB9S301	300 (270~330)	195	250	500	10	1200	21.5	0.25
TVB9S331	330 (297~363)	215	275	550	10	1200	22.0	0.25
TVB9S361	360 (324~396)	230	300	595	10	1200	23.0	0.25
TVB9S391	390 (351~429)	250	320	650	10	1200	25.0	0.25
TVB9S431	430 (387~473)	275	350	710	10	1200	29.0	0.25
TVB9S471	470 (423~517)	300	385	775	10	1200	30.0	0.25
TVB9S511	510 (459~561)	320	410	845	10	1200	33.0	0.25
TVB9S561	560 (504~616)	350	450	930	10	1200	33.0	0.25
TVB9S621	620 (558~682)	395	510	1020	10	1200	35.0	0.25
TVB9S681	680 (612~748)	420	560	1120	10	1200	35.0	0.25
TVB9S751	750 (675~825)	460	615	1235	10	1200	50.5	0.25

Metal Oxide Varistor : TVB Series



Plastic Encapsulated Type Varistor for Surge Protection

TVBDS Series (5548 Size)

Part No.	Varistor Voltage (@ 1mA DC)	Max. Continuous Voltage		Max. Clamping Voltage (8/20 μ s)		Max. Surge Current (8/20 μ s)	Max. Energy (10/1000 μ s)	Rated Power
	V _{1mA} (V)	V _{AC(rms)} (V)	V _{DC} (V)	V _P (V)	I _P (A)	I _{max} (A)	W _{max} (J)	P (W)
TVBDS270	27(24~30)	17	22	53	5	500	3.9	0.05
TVBDS330	33(30~36)	20	26	65	5	500	4.8	0.05
TVBDS390	39(35~43)	25	31	77	5	500	5.6	0.05
TVBDS470	47(42~52)	30	38	93	5	500	6.8	0.05
TVBDS560	56(50~62)	35	45	125	5	500	8.1	0.05
TVBDS680	68(61~75)	40	56	135	5	500	9.8	0.05
TVBDS820	82(74~90)	50	65	150	25	3500	14	0.4
TVBDS101	100(90~110)	60	85	165	25	3500	17	0.4
TVBDS121	120(108~132)	75	100	200	25	3500	20	0.4
TVBDS151	150(135~165)	95	125	250	25	3500	25	0.4
TVBDS181	180(162~198)	115	150	300	25	3500	30	0.4
TVBDS201	205(185~226)	130	170	340	25	3500	35	0.4
TVBDS221	220(198~242)	140	180	360	25	3500	39	0.4
TVBDS241	240(216~264)	150	200	395	25	3500	42	0.4
TVBDS271	270(243~297)	175	225	455	25	3500	49	0.4
TVBDS301	300(270~330)	195	250	500	25	3500	53	0.4
TVBDS331	330(297~363)	215	275	550	25	3500	58	0.4
TVBDS361	360(324~396)	230	300	595	25	3500	65	0.4
TVBDS391	390(351~429)	250	320	650	25	3500	70	0.4
TVBDS431	430(387~473)	275	350	710	25	3500	80	0.4
TVBDS471	475(428~523)	300	385	775	25	3500	85	0.4
TVBDS511	510(459~561)	320	410	845	25	3500	92	0.4
TVBDS561	560(504~616)	350	450	930	25	3500	92	0.4
TVBDS621	620(558~682)	395	510	1020	25	3500	95	0.4
TVBDS681	680(612~748)	420	560	1120	25	3500	98	0.4
TVBDS751	750(675~825)	465	615	1235	25	3500	100	0.4

Metal Oxide Varistor : TVB Series



Plastic Encapsulated Type Varistor for Surge Protection

TVES Series (6255 Size)

Part No.	Varistor Voltage (@ 1mA DC)	Max. Continuous Voltage		Max. Clamping Voltage (8/20 μ s)		Max. Surge Current (8/20 μ s)	Max. Energy (10/1000 μ s)	Rated Power
	V _{1mA} (V)	V _{AC(rms)} (V)	V _{DC} (V)	V _P (V)	I _P (A)	I _{max} (A)	W _{max} (J)	P (W)
TVBES270	27(24~30)	17	22	53	10	1000	6	0.1
TVBES330	33(30~36)	20	26	65	10	1000	7	0.1
TVBES390	39(35~43)	25	31	77	10	1000	8	0.1
TVBES470	47(42~52)	30	38	93	10	1000	10	0.1
TVBES560	56(50~62)	35	45	125	10	1000	12	0.1
TVBES680	68(61~75)	40	56	135	10	1000	15	0.1
TVBES820	82(74~90)	50	65	150	50	4500	21	0.6
TVBES101	100(90~110)	60	85	165	50	4500	26	0.6
TVBES121	120(108~132)	75	100	200	50	4500	31	0.6
TVBES151	150(135~165)	95	125	250	50	4500	40	0.6
TVBES181	180(162~198)	115	150	300	50	4500	47	0.6
TVBES201	205(185~226)	130	170	340	50	4500	52	0.6
TVBES221	220(198~242)	140	180	360	50	4500	58	0.6
TVBES241	240(216~264)	150	200	395	50	4500	64	0.6
TVBES271	270(243~297)	175	225	455	50	4500	67	0.6
TVBES301	300(270~330)	195	250	500	50	4500	70	0.6
TVBES331	330(297~363)	215	275	550	50	4500	72	0.6
TVBES361	360(324~396)	230	300	595	50	4500	76	0.6
TVBES391	390(351~429)	250	320	650	50	4500	82	0.6
TVBES431	430(387~473)	275	350	710	50	4500	93	0.6
TVBES471	475(428~523)	300	385	775	50	4500	99	0.6
TVBES511	510(459~561)	320	410	845	50	4500	107	0.6
TVBES561	560(504~616)	350	450	930	50	4500	113	0.6
TVBES621	620(558~682)	395	510	1020	50	4500	125	0.6
TVBES681	680(612~748)	420	560	1120	50	4500	128	0.6
TVBES751	750(675~825)	460	615	1235	50	4500	134	0.6

Metal Oxide Varistor : TVB Series

Plastic Encapsulated Type Varistor for Surge Protection



■ Safety Approvals

Certified Model No.	Agency		Certified Model No.	Agency	
					
	UL1449 4 th & cUL	EN/IEC 61051-1 IEC 61051-2 IEC 61051-2-2		UL1449 4 th & cUL	EN/IEC 61051-1 IEC 61051-2 IEC 61051-2-2
	E314979	J50282205		E314979	J50282205
TVB7S180	√	√	TVB9S180	√	√
TVB7S220	√	√	TVB9S220	√	√
TVB7S270	√	√	TVB9S270	√	√
TVB7S330	√	√	TVB9S330	√	√
TVB7S390	√	√	TVB9S390	√	√
TVB7S470	√	√	TVB9S470	√	√
TVB7S560	√	√	TVB9S560	√	√
TVB7S680	√	√	TVB9S680	√	√
TVB7S820	√	√	TVB9S820	√	√
TVB7S101	√	√	TVB9S101	√	√
TVB7S121	√	√	TVB9S121	√	√
TVB7S151	√	√	TVB9S151	√	√
TVB7S181	√	√	TVB9S181	√	√
TVB7S201	√	√	TVB9S201	√	√
TVB7S221	√	√	TVB9S221	√	√
TVB7S241	√	√	TVB9S241	√	√
TVB7S271	√	√	TVB9S271	√	√
TVB7S361	√	√	TVB9S331	√	√
TVB7S391	√	√	TVB9S361	√	√
TVB7S431	√	√	TVB9S391	√	√
TVB7S471	√	√	TVB9S431	√	√
TVB7S511	√	√	TVB9S471	√	√
TVB7S561	√	√	TVB9S511	√	√
			TVB9S561	√	√
			TVB9S621	√	√
			TVB9S681	√	√
			TVB9S751	√	√

Metal Oxide Varistor : TVB Series



Plastic Encapsulated Type Varistor for Surge Protection

■ Safety Approvals

Certified Model No.	Agency				
	UL1449 5 th & cUL	EN/IEC 61051-1 IEC 61051-2 IEC 61051-2-2	IEC 62368-1:2018 G.8.1	GB/T10193-1997 GB/T10194-1997	GB4943.1-2011 GB 8898-2011
	E314979	J50517635		Pending	
TVBDS270	√	√		√	
TVBDS330	√	√		√	
TVBDS390	√	√		√	
TVBDS470	√	√		√	
TVBDS560	√	√		√	
TVBDS680	√	√		√	
TVBDS820	√	√		√	
TVBDS101	√	√		√	
TVBDS121	√	√		√	
TVBDS151	√	√		√	
TVBDS181	√	√	√	√	
TVBDS201	√	√	√	√	
TVBDS221	√	√	√	√	
TVBDS241	√	√	√	√	
TVBDS271	√	√	√	√	
TVBDS301	√	√	√	√	
TVBDS331	√	√	√	√	
TVBDS361	√	√	√	√	
TVBDS391	√	√	√	√	
TVBDS431	√	√	√	√	√
TVBDS471	√	√	√	√	√
TVBDS511	√	√	√	√	√
TVBDS561	√	√	√	√	√
TVBDS621	√	√	√	√	√
TVBDS681	√	√	√	√	√
TVBDS751	√	√	√	√	√

Metal Oxide Varistor : TVB Series

Plastic Encapsulated Type Varistor for Surge Protection



■ Safety Approvals

Certified Model No.	Agency				
	UL1449 4 th & cUL	EN/IEC 61051-1 IEC 61051-2 IEC 61051-2-2	IEC62368-1:2018 G.8.1	GB/T10193-1997 GB/T10194-1997	GB4943.1-2011GB88 98-2011
	E314979	J50477949		CQC20001267007	
TVBES270	√	√		√	
TVBES330	√	√		√	
TVBES390	√	√		√	
TVBES470	√	√		√	
TVBES560	√	√		√	
TVBES680	√	√		√	
TVBES820	√	√		√	
TVBES101	√	√		√	
TVBES121	√	√		√	
TVBES151	√	√		√	
TVBES181	√	√	√	√	
TVBES201	√	√	√	√	
TVBES221	√	√	√	√	
TVBES241	√	√	√	√	
TVBES271	√	√	√	√	
TVBES301	√	√	√	√	
TVBES331	√	√	√	√	
TVBES361	√	√	√	√	
TVBES391	√	√	√	√	
TVBES431	√	√	√	√	√
TVBES471	√	√	√	√	√
TVBES511	√	√	√	√	√
TVBES561	√	√	√	√	√
TVBES621	√	√	√	√	√
TVBES681	√	√	√	√	√
TVBES751	√	√	√	√	√

Metal Oxide Varistor : TVB Series



Plastic Encapsulated Type Varistor for Surge Protection

■ Power Derating Curve

- TVB7S Series & TVB9S Series

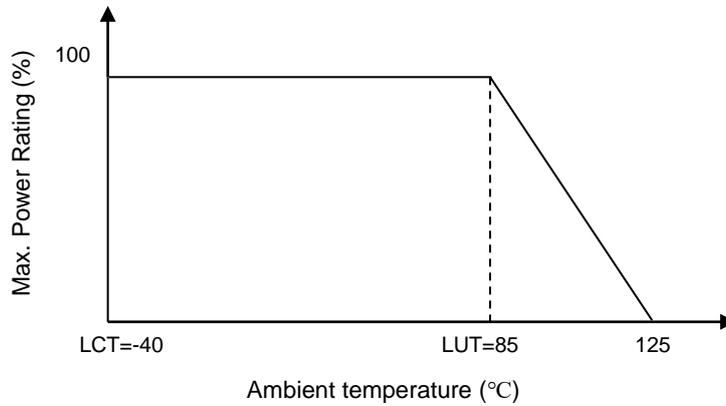

- TVBDS Series & TVBES Series

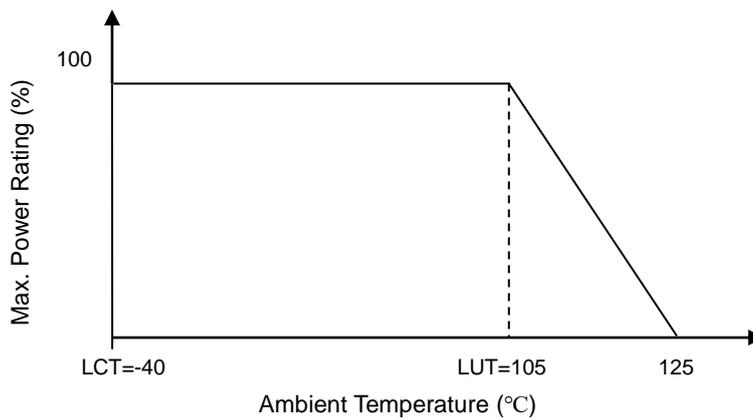

■ Surge Current Standard Waveform

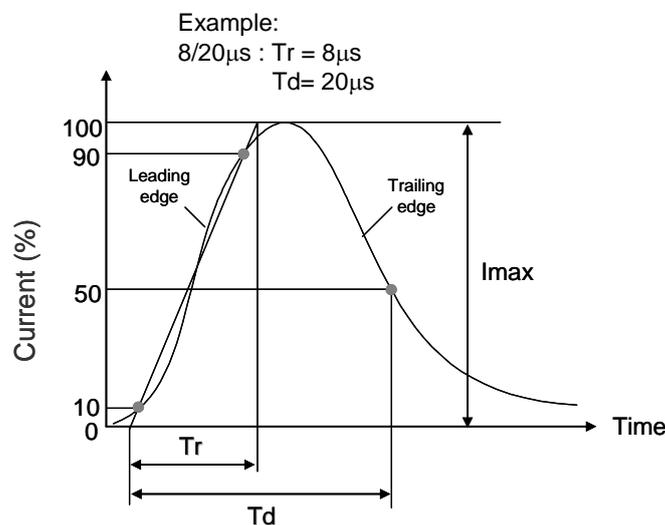

Metal Oxide Varistor : TVB Series



Plastic Encapsulated Type Varistor for Surge Protection

Max. Surge Current Derating Curves

TVB7S180 to TVB7S680

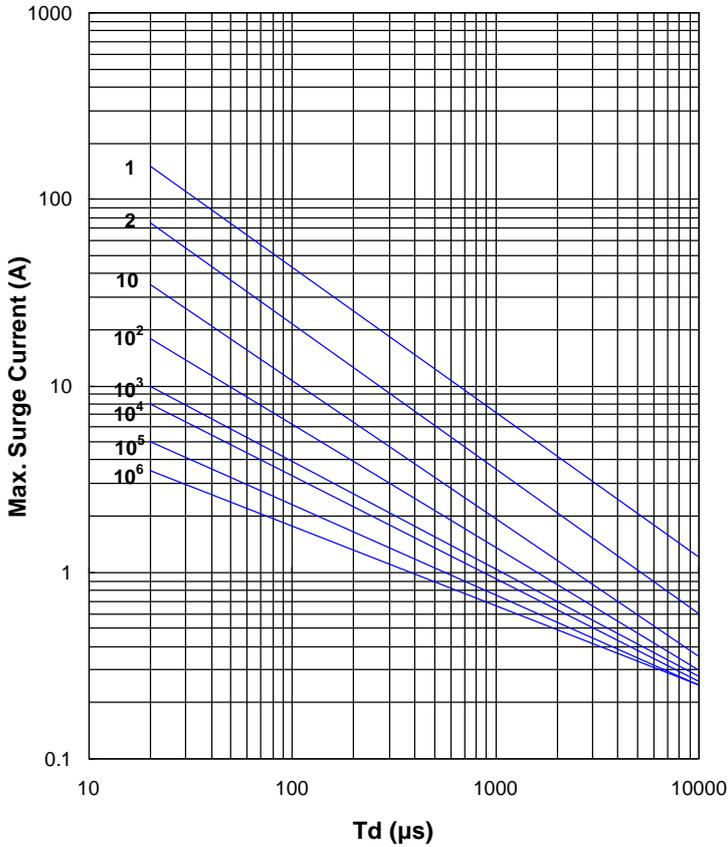

TVB7S820 to TVB7S561

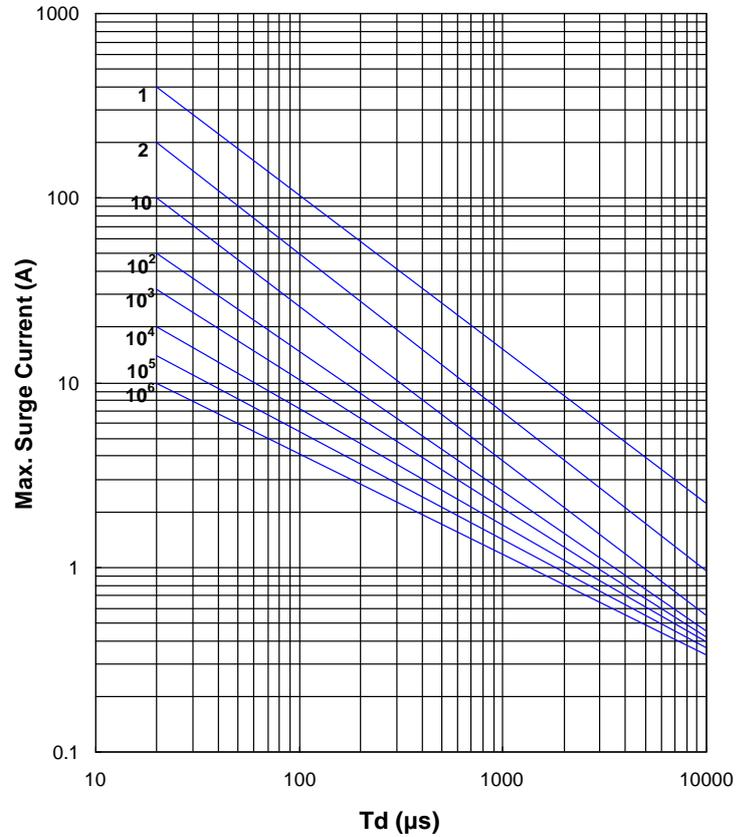

TVB9S180 to TVB9S680

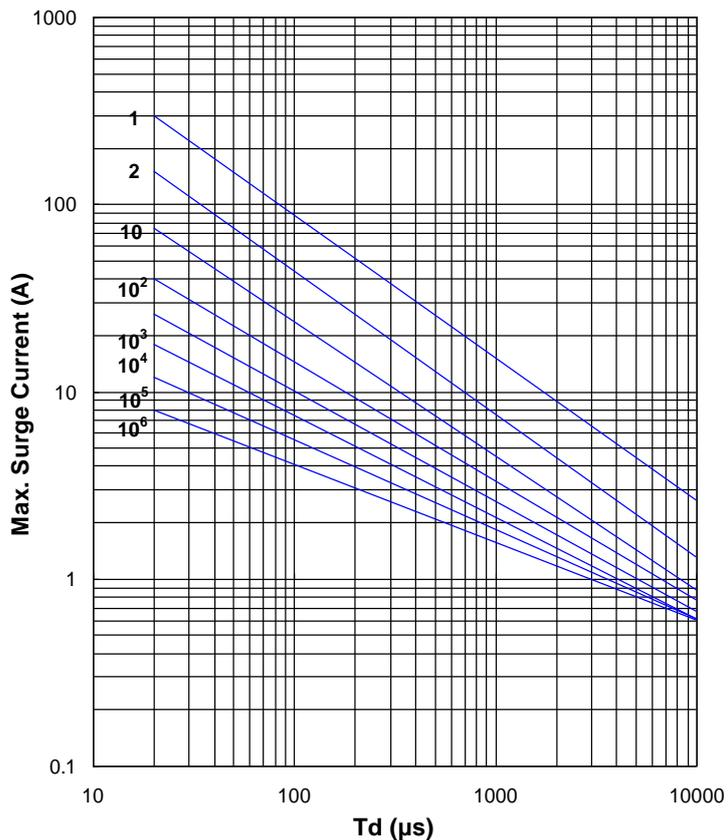

TVB9S820 to TVB9S751

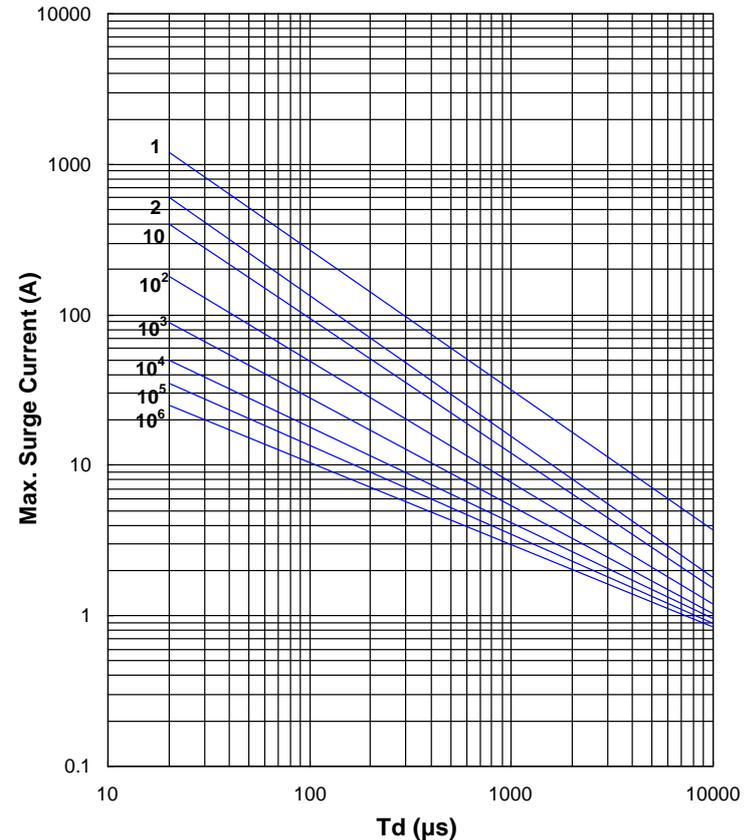

Metal Oxide Varistor : TVB Series



Plastic Encapsulated Type Varistor for Surge Protection

Max. Surge Current Derating Curves

TVBDS270 to TVBDS680

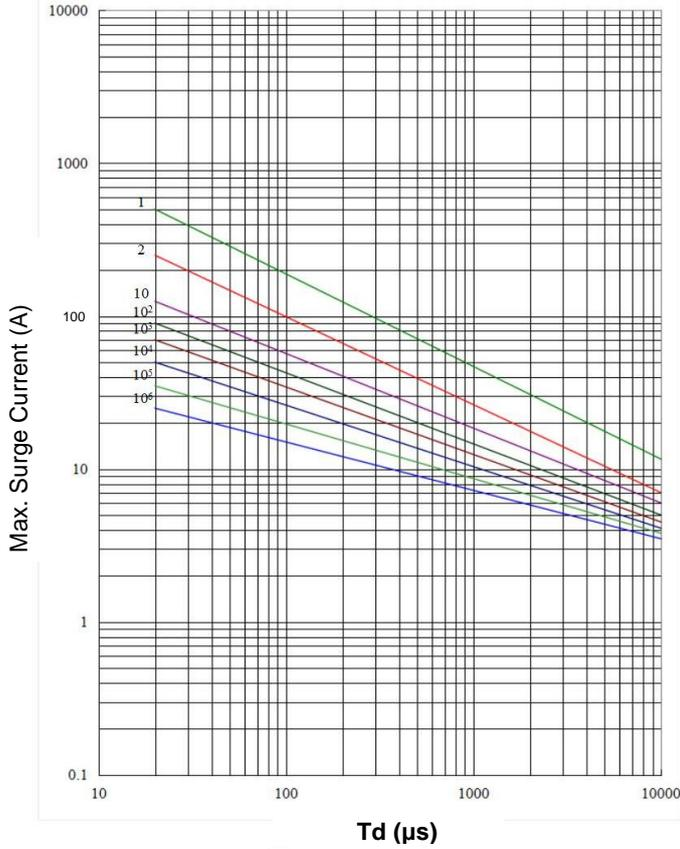

TVB DS820 to TVB DS751

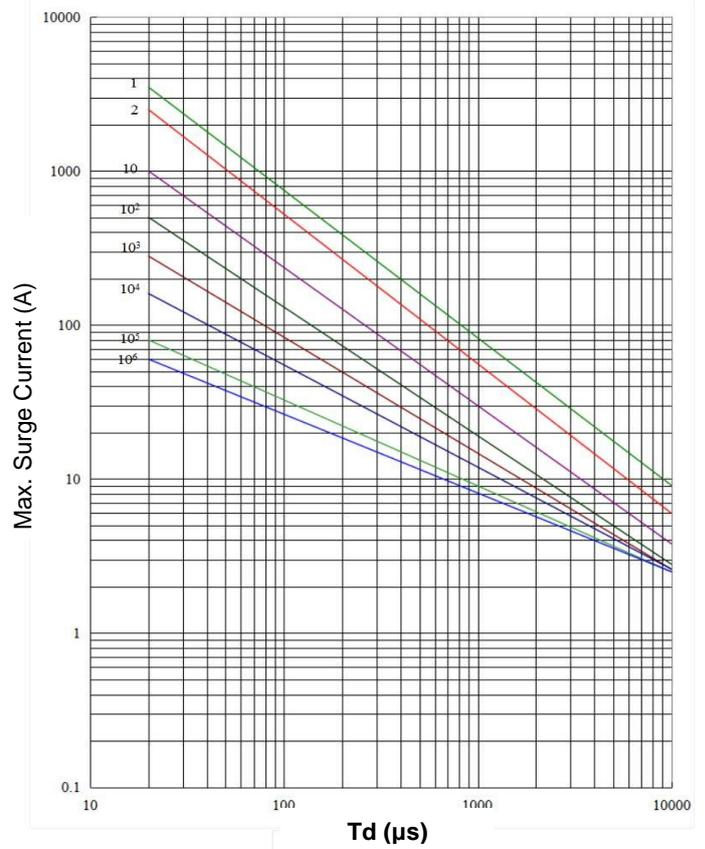

TVBES270 to TVBES680

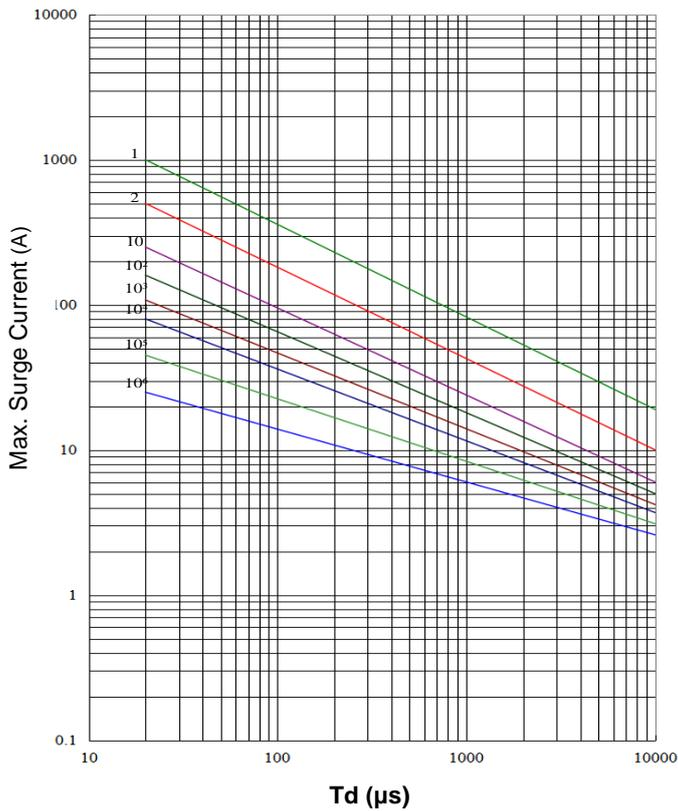

TVBES820 to TVBES751

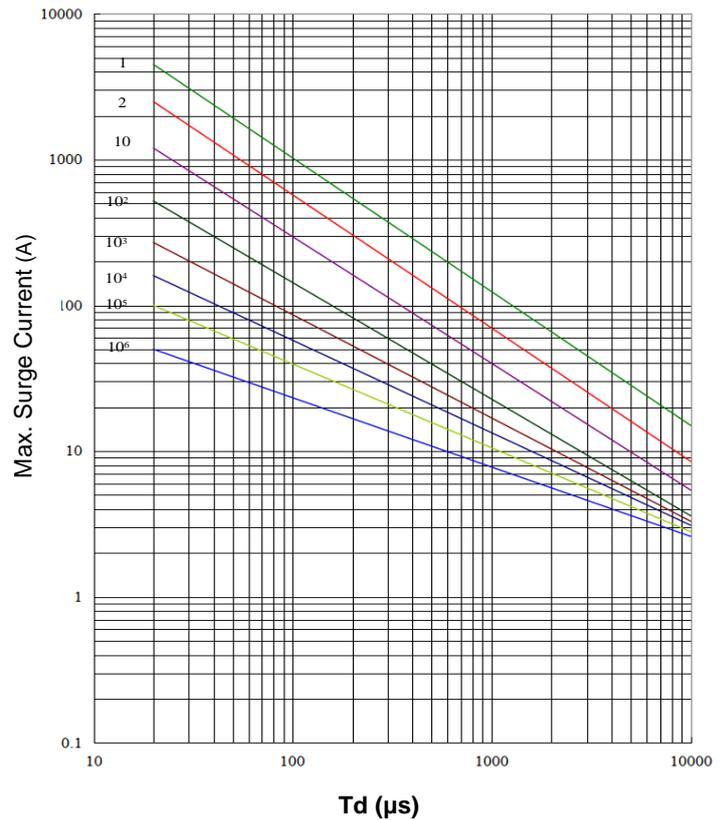

Metal Oxide Varistor : TVB Series

Plastic Encapsulated Type Varistor for Surge Protection



Max. Leakage Current and Max. Clamping Voltage Curves

Max. Leakage Current and Max. Clamping Voltage Curves (TVB7S180 to TVB7S680)

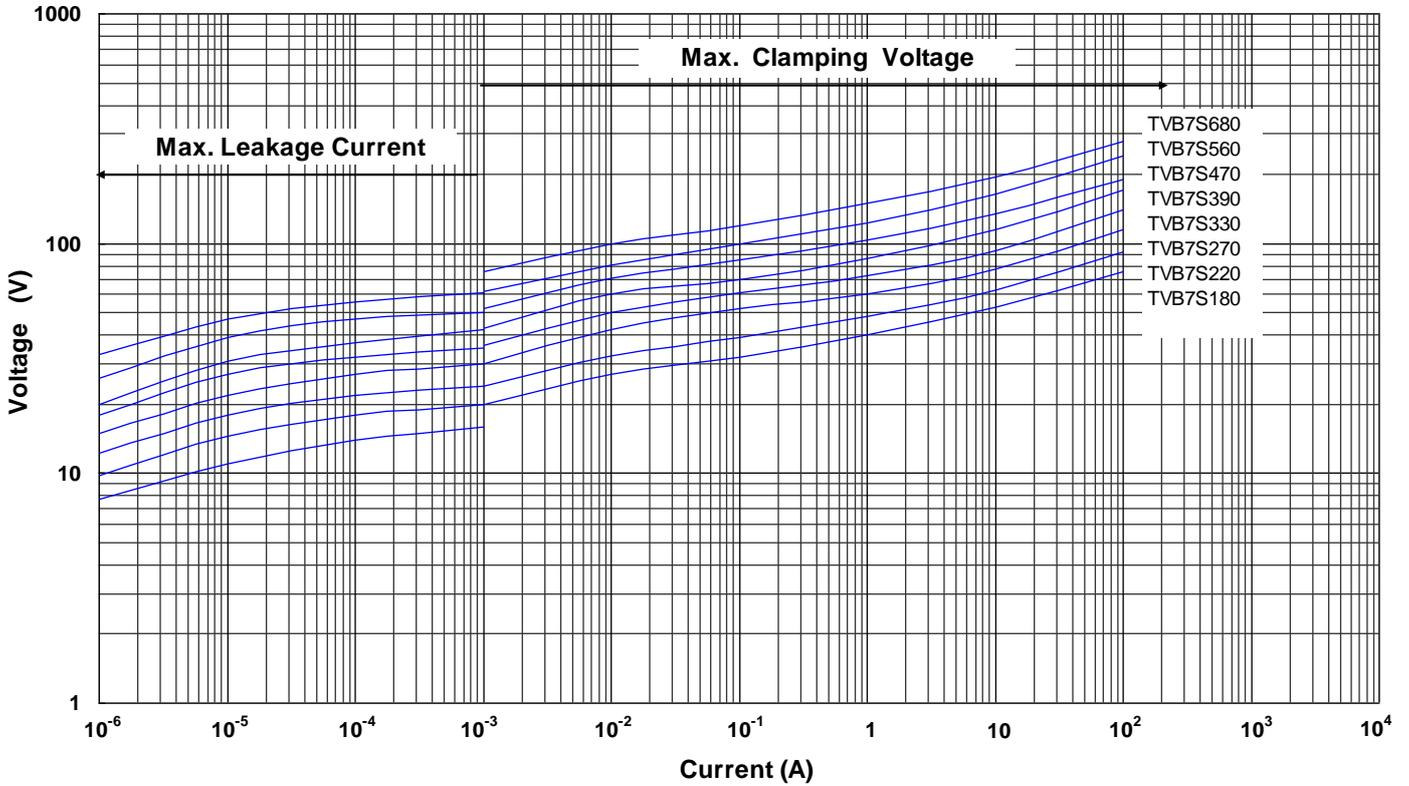

Max. Leakage Current and Max. Clamping Voltage Curves (TVB7S820 to TVB7S561)

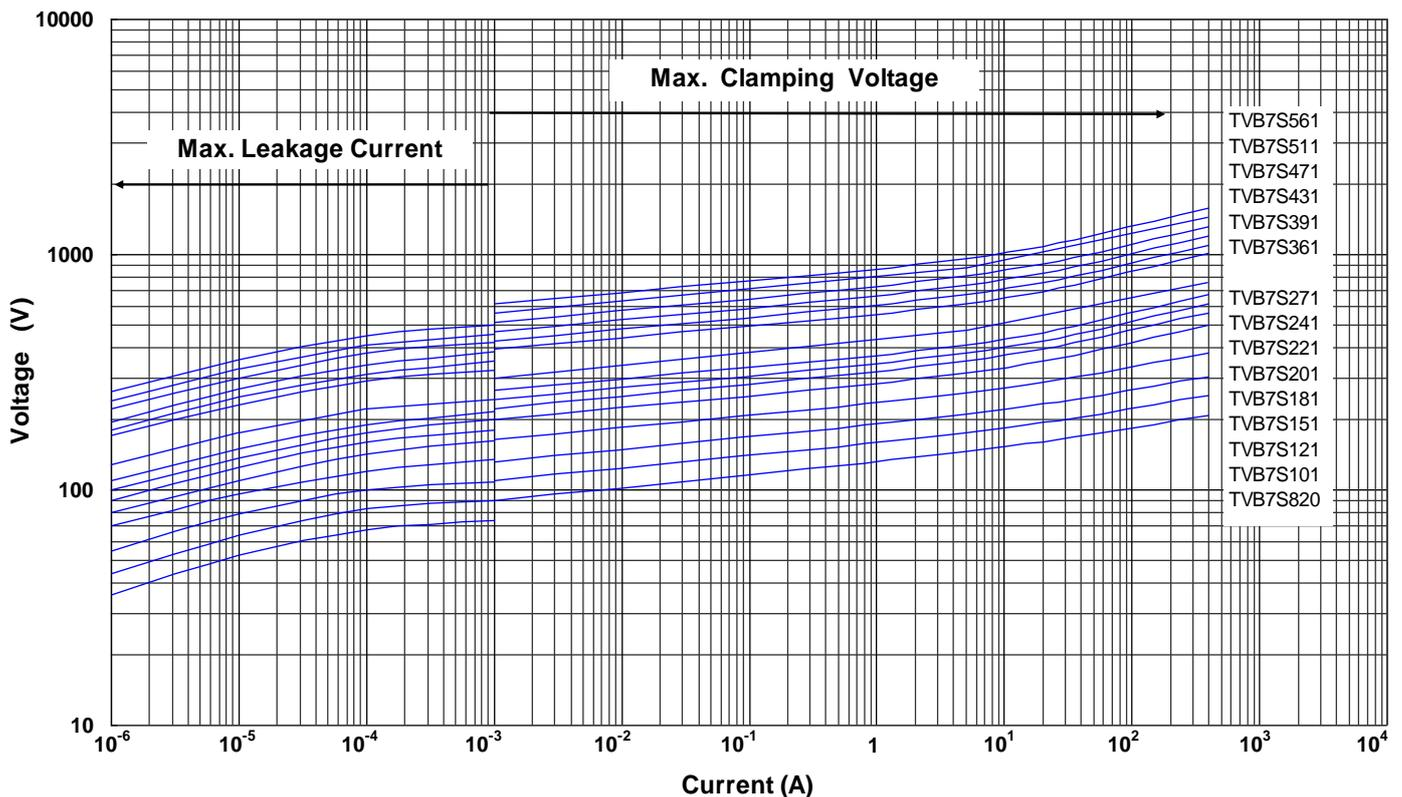

Metal Oxide Varistor : TVB Series

Plastic Encapsulated Type Varistor for Surge Protection



■ Max. Leakage Current and Max. Clamping Voltage Curves

Max. Leakage Current and Max. Clamping Voltage Curves (TVB9S180 to TVB9S680)

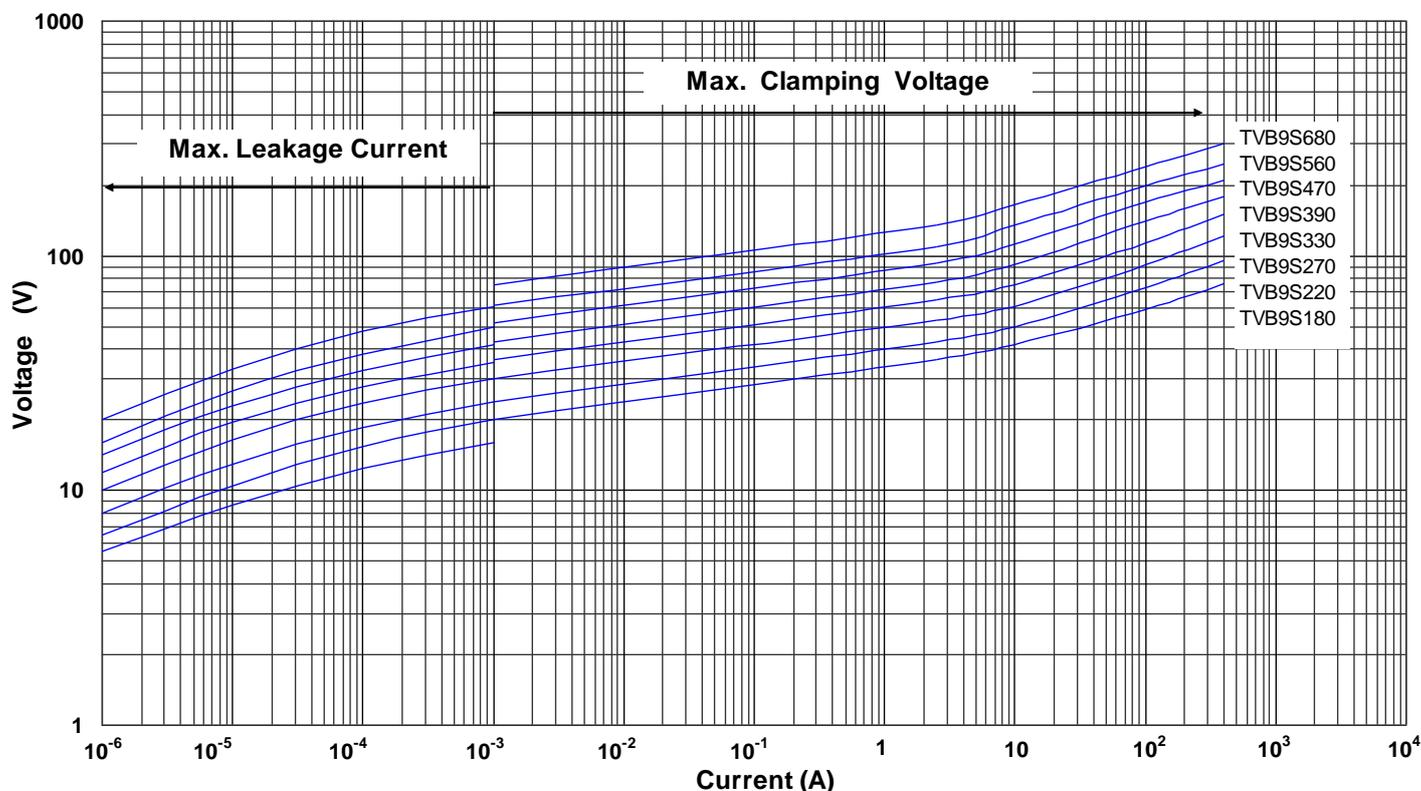

Max. Leakage Current and Max. Clamping Voltage Curves (TVB9S820 to TVB9S471)

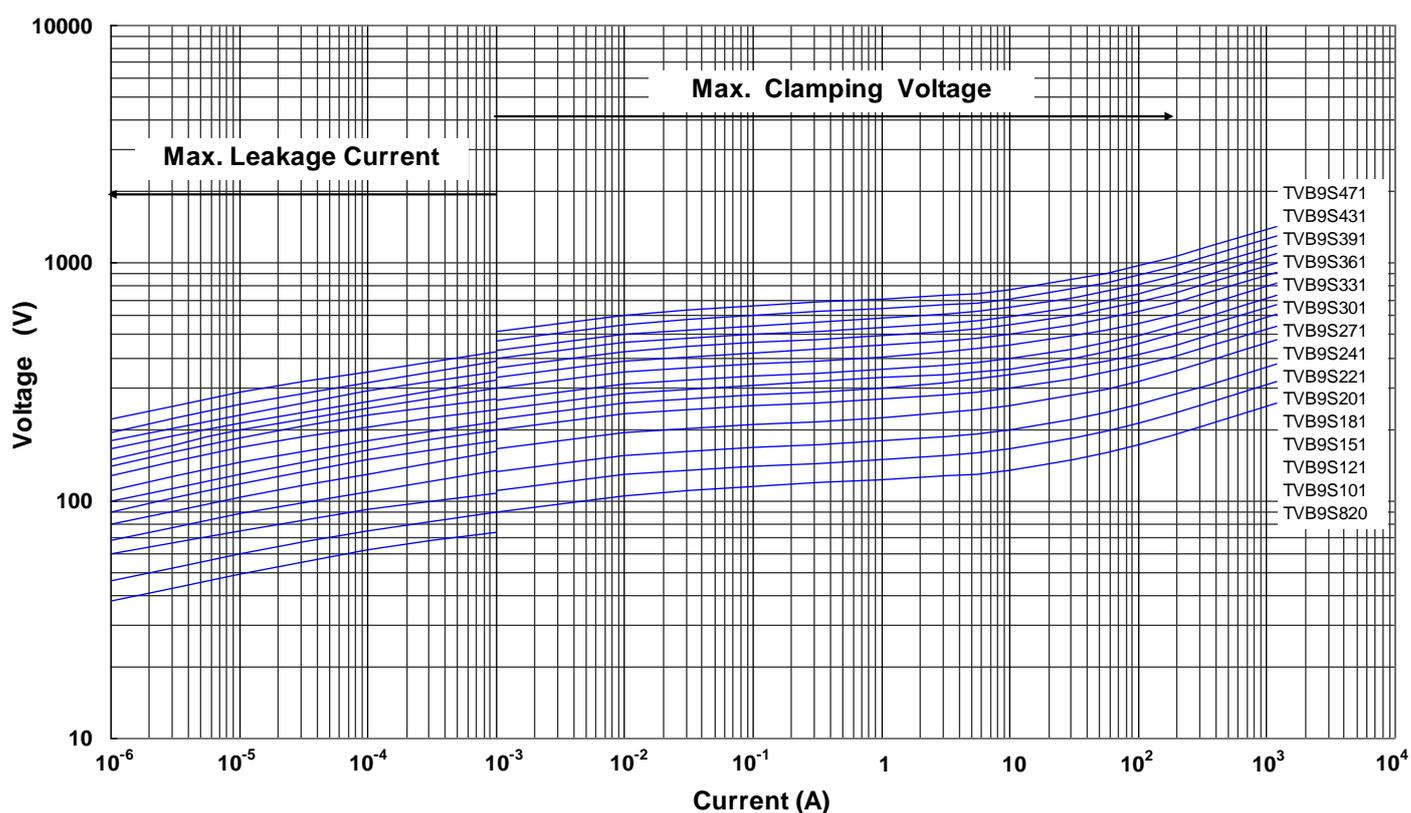

Metal Oxide Varistor : TVB Series



Plastic Encapsulated Type Varistor for Surge Protection

■ Max. Leakage Current and Max. Clamping Voltage Curves

Max. Leakage Current and Max. Clamping Voltage Curves (TVB9S511 to TVB9S751)

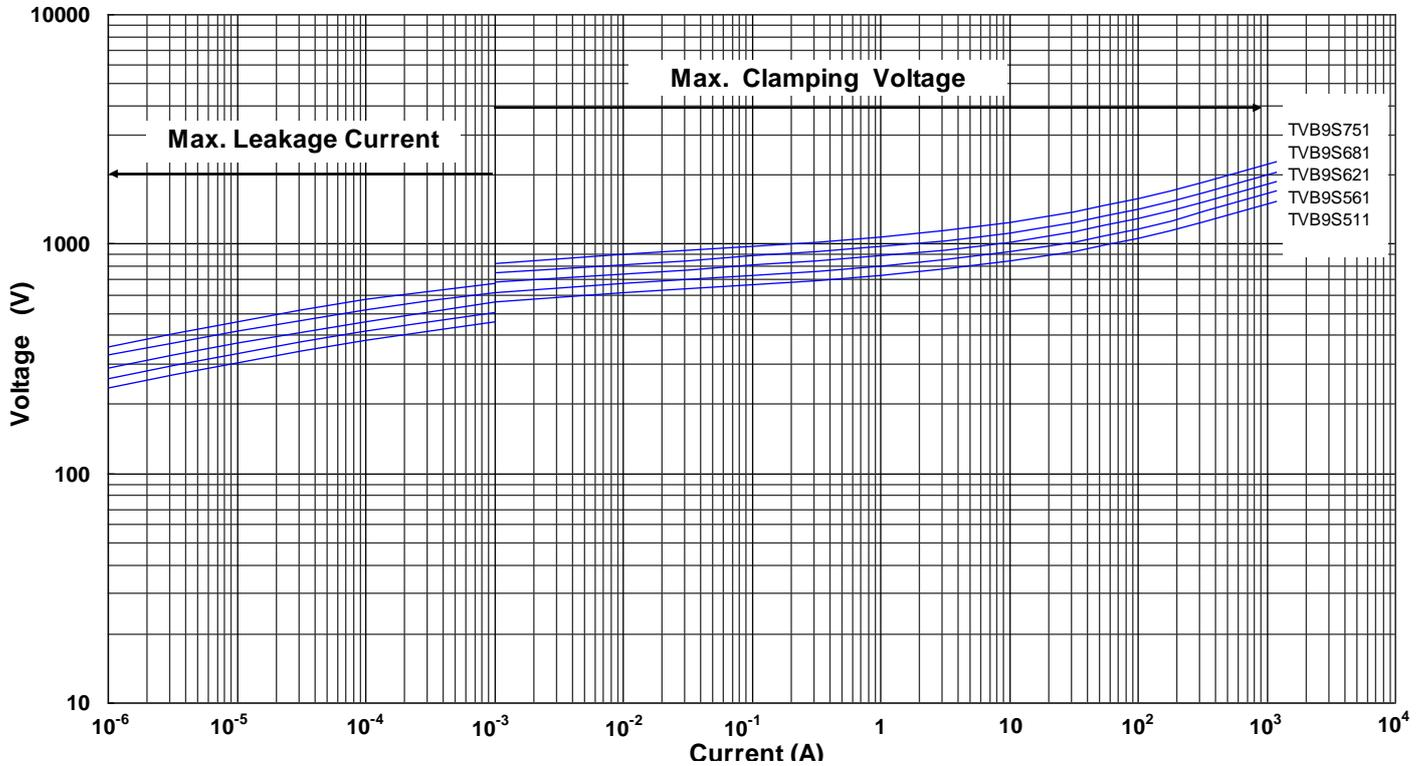

Max. Leakage Current and Max. Clamping Voltage Curves (TVBDS820 to TVBDS751)

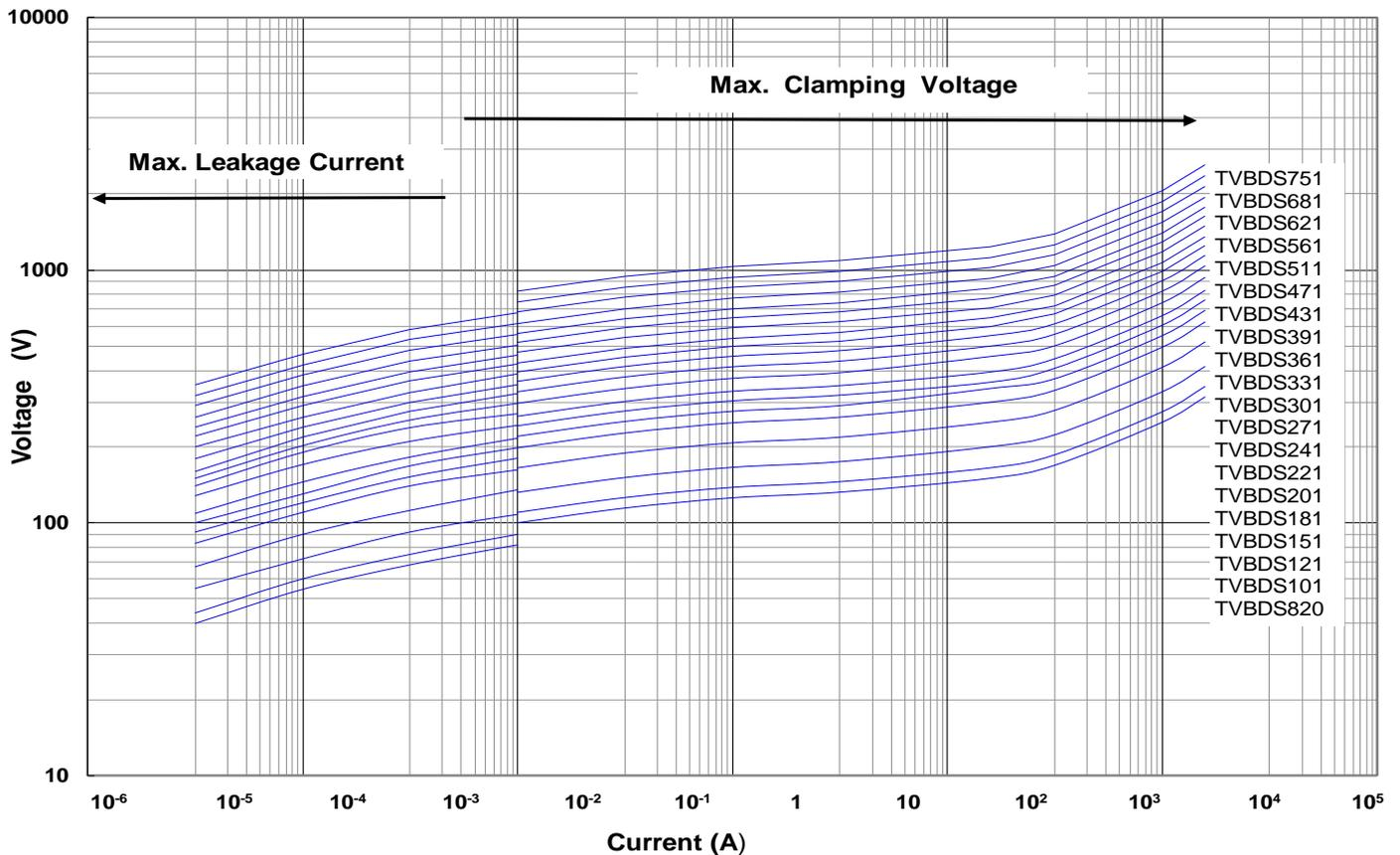

Metal Oxide Varistor : TVB Series

Plastic Encapsulated Type Varistor for Surge Protection



Max. Leakage Current and Max. Clamping Voltage Curves

Max. Leakage Current and Max. Clamping Voltage Curves (TVBES270 to TVBES680)

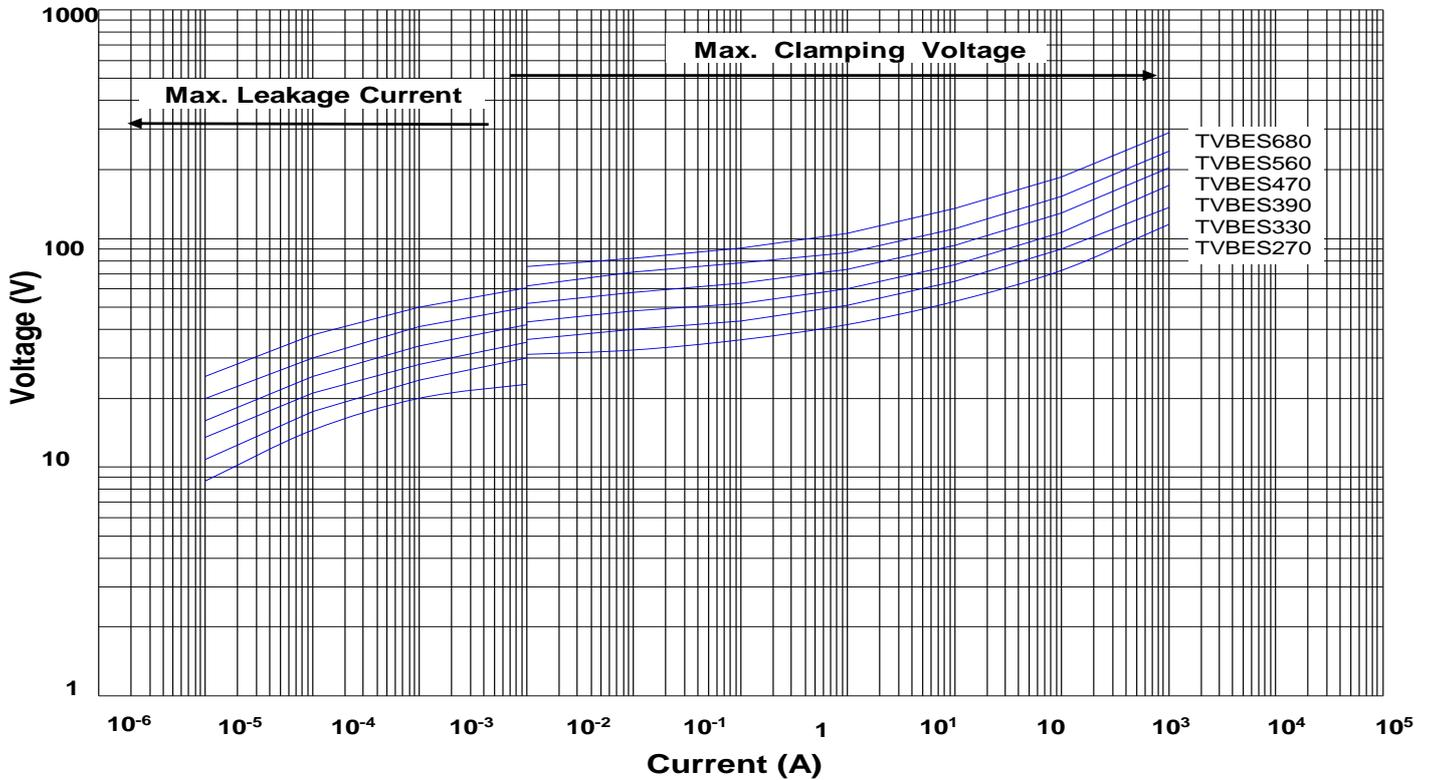

Max. Leakage Current and Max. Clamping Voltage Curves (TVBES820 to TVBES751)

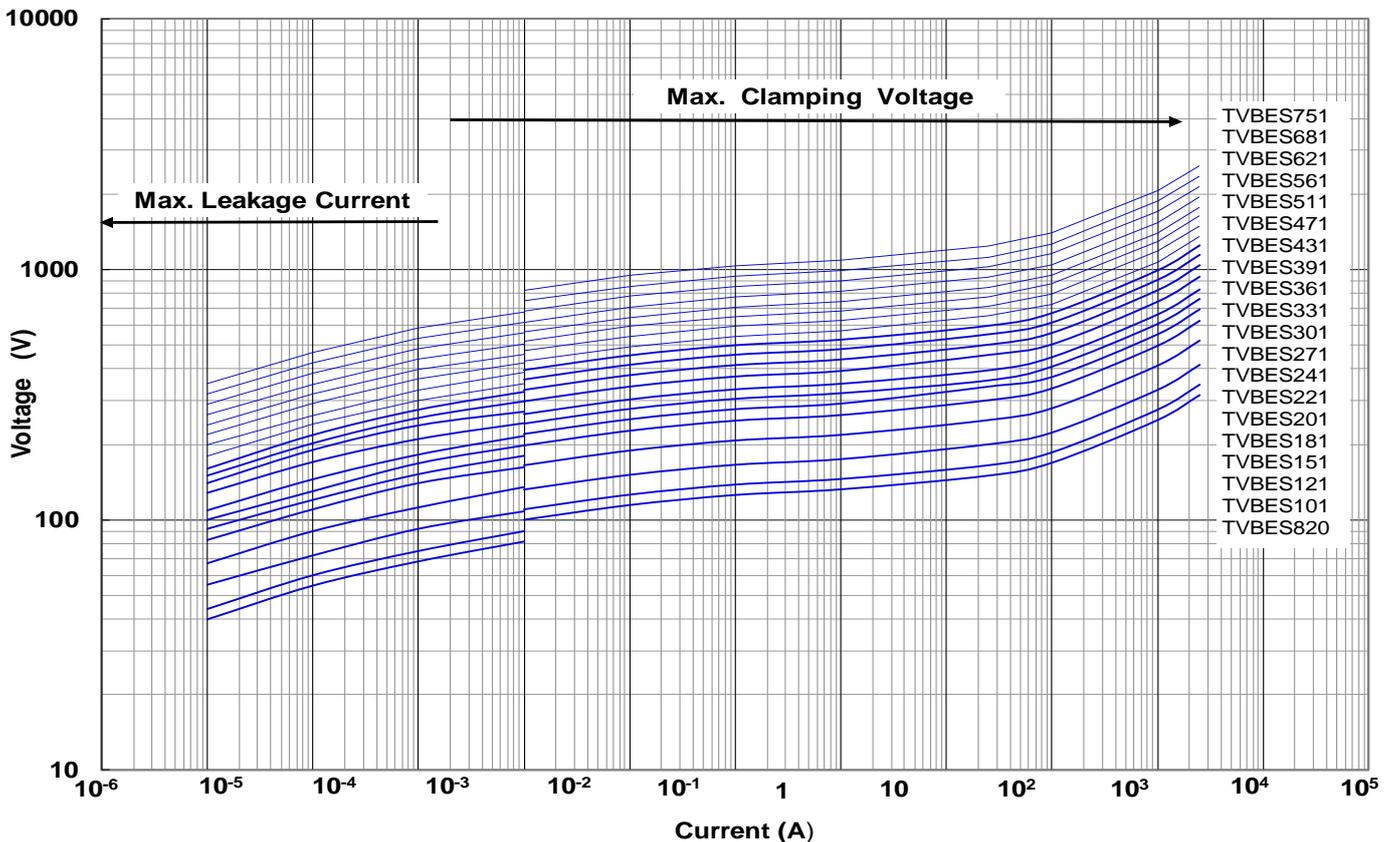

Metal Oxide Varistor : TVB Series



Plastic Encapsulated Type Varistor for Surge Protection

■ Soldering Recommendation

● IR-reflow Soldering Profile

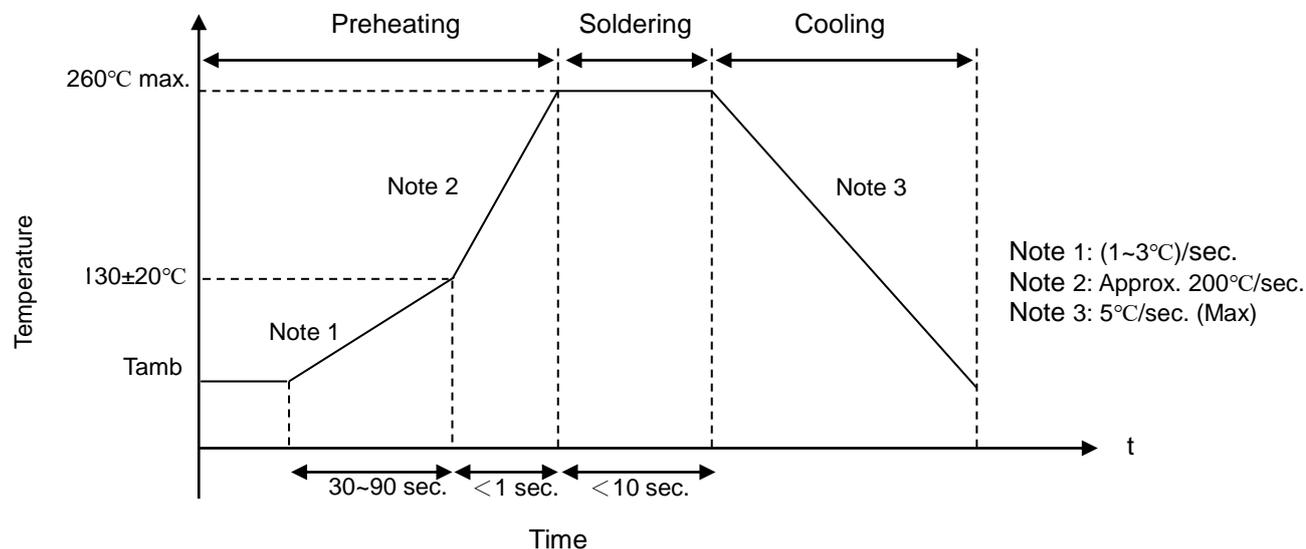

● Recommended Reworking Conditions with Soldering Iron

Item	Conditions
Temperature of Soldering Iron-tip	360°C (max.)
Soldering Time	3 sec (max.)
Diameter of Soldering Iron-tip	Φ3 mm (max.)

Metal Oxide Varistor : TVB Series



Plastic Encapsulated Type Varistor for Surge Protection

■ Reliability

Item	Standard	Test conditions / Methods	Specifications															
Vibration	IEC 60068-2-6	Frequency range: 10~55Hz Amplitude: 0.75mm or 98m/s ² Direction: 3 mutually perpendicular directions, 2 hrs each.	$ \Delta V_{1mA}/V_{1mA} \leq \pm 5\%$ No visible damage															
Solderability	IEC 60068-2-20	245±3°C, 3±0.3 sec	At least 95% of terminal electrode is covered by new solder															
Resistance to Soldering Heat	IEC 60068-2-20	260±5°C TVB7S Series: 5±1 sec TVB9S/TVBDS/TVBES Series: 10±1 sec	$ \Delta V_{1mA}/V_{1mA} \leq \pm 5\%$ No visible damage															
High Temperature Storage	IEC 60068-2-2	125±5°C x 1000 ±24 hrs	$ \Delta V_{1mA}/V_{1mA} \leq \pm 5\%$ No visible damage															
Damp Heat, Steady State	IEC60068-2-78	a. 40±2°C, 90 ~ 95 % RH, 1344 hrs. b. 40±2°C, 90 ~ 95 % RH, at 10%Vdc, 1344 hrs	$ \Delta V_{1mA}/V_{1mA} \leq \pm 5\%$ No visible damage Insulation Resistance ≥ 100MΩ															
Rapid Change of Temperature	IEC 60068-2-14	The conditions shown below shall be repeated 5 cycles <table border="1"> <thead> <tr> <th>Step</th> <th>Temperature (°C)</th> <th>Period (minutes)</th> </tr> </thead> <tbody> <tr> <td>1</td> <td>-40±3</td> <td>30±3</td> </tr> <tr> <td>2</td> <td>Room temperature</td> <td>5±3</td> </tr> <tr> <td>3</td> <td>TVB7S/TVB9S: +85±2 TVBDS/TVBES Series: +105±2</td> <td>30±3</td> </tr> <tr> <td>4</td> <td>Room temperature</td> <td>5±3</td> </tr> </tbody> </table>	Step	Temperature (°C)	Period (minutes)	1	-40±3	30±3	2	Room temperature	5±3	3	TVB7S/TVB9S: +85±2 TVBDS/TVBES Series: +105±2	30±3	4	Room temperature	5±3	$ \Delta V_{1mA}/V_{1mA} \leq 5\%$ No visible damage
Step	Temperature (°C)	Period (minutes)																
1	-40±3	30±3																
2	Room temperature	5±3																
3	TVB7S/TVB9S: +85±2 TVBDS/TVBES Series: +105±2	30±3																
4	Room temperature	5±3																
High Temp. Load	MIL-STD-202 Method 108	TVB7S & TVB9S Series: 85°C TVBDS & TVB S Series: 105°C 1000±24 hrs at V _{DC} or V _{rms} (Max. Continuous Voltage)	$ \Delta V_{1mA}/V_{1mA} \leq 10\%$ No visible damage															
8/20μs Surge Life	IEC 61051-1	8/20μs waveform, 10 surge currents, unipolar, interval 30 sec, amplitude corresponding to max. surge current derating curves for 20μs.	$ \Delta V_{1mA}/V_{1mA} \leq \pm 10\%$ No visible damage															
10/1000μs Surge Life	IEC 61051-1	10/1000μs waveform, 10 surge currents, unipolar, interval 2 mins, amplitude corresponding to max. surge current derating curves for 1000μs.	$ \Delta V_{1mA}/V_{1mA} \leq \pm 10\%$ No visible damage															
Voltage Proof	IEC 61051-1	Metal balls method, 2500 V _{ac} 1 min	No visible damage															
Varistor Voltage Temp. Coefficient	Specification Standard	TVB7S & TVB9S Series: Varistor voltage is measured at -40°C, +85°C, and +25°C TVBDS & TVBES Series: Varistor voltage is measured at -40°C, +105°C, and +25°C	-0.05~0.05 %/°C															

Metal Oxide Varistor : TVB Series



Plastic Encapsulated Type Varistor for Surge Protection

■ Packaging

● Taping Specification (TVB7S/TVB9S/TVBDS Series)

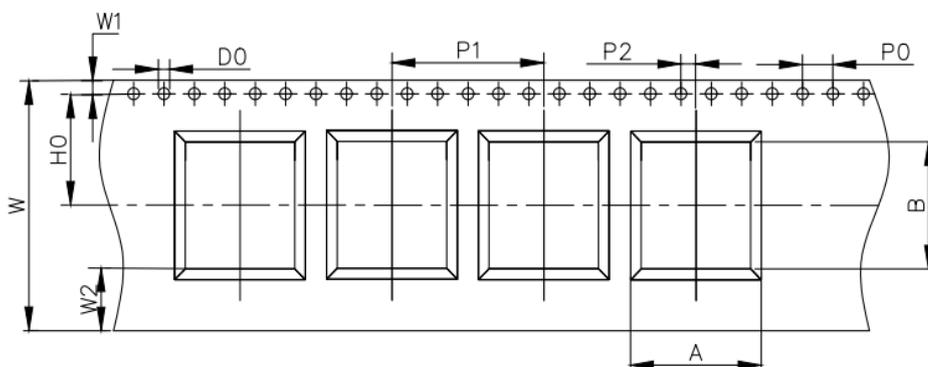

(Unit: mm)

Item	A*B	P ₀	P ₁	P ₂	H ₀	W	W ₁	W ₂	D ₀
Tolerance	±0.2	±0.1	±0.1	±0.05	±0.05	±0.3	±0.1	Min.	+0.1/0
Size	3225	7*8.7	4	12	2	7.5	16	1.75	1.5
	4032	8.6*10.6							
	5548	12.5*14.3	4	20	2	11.5	24	1.75	3.6

● Taping Specification (TVBES Series)

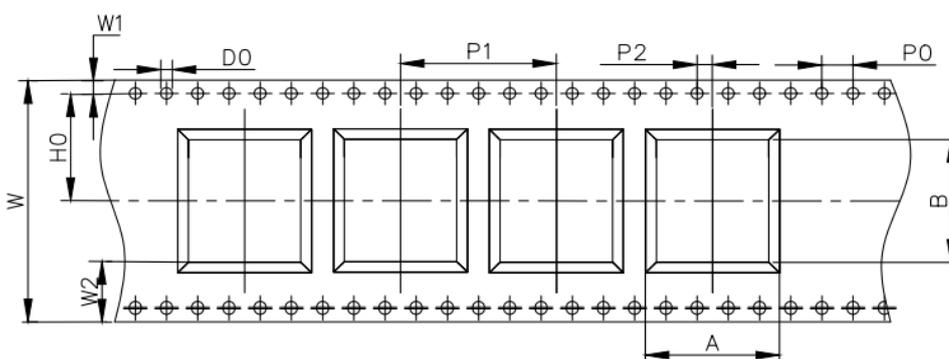

(Unit: mm)

Item	A*B	P ₀	P ₁	P ₂	H ₀	W	W ₁	W ₂	D ₀	
Tolerance	±0.2	±0.1	±0.1	±0.05	±0.05	±0.3	±0.1	Min.	+0.1/0	
Size	6255	14.7*16.4	4	20	2	14.2	32	1.75	7.9	1.5

Metal Oxide Varistor : TVB Series

Plastic Encapsulated Type Varistor for Surge Protection



- Quantity

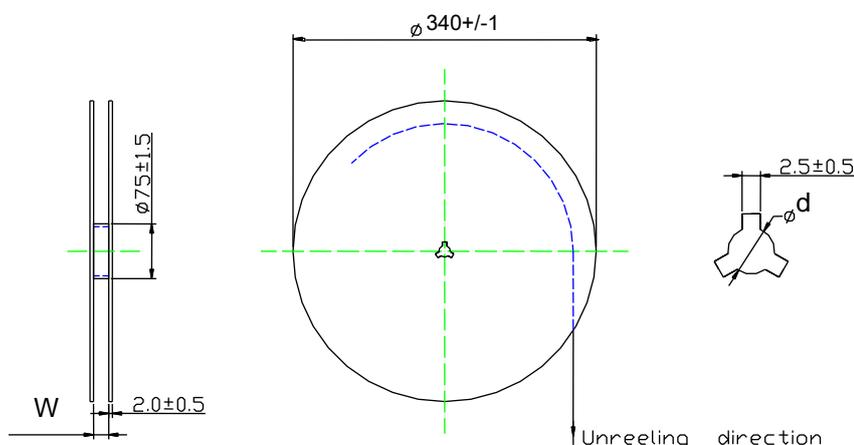

Size	Quantity (pcs/reel)	W	ϕd
3225	1,000	17 ± 0.5	12.5 ± 1
4032	1,000	17 ± 0.5	12.5 ± 1
5548	500	25 ± 1	$13.5 +1/-0.5$
6255	500	33 ± 1	$13.5 +1/-0.5$

■ Warehouse Storage Conditions of Products

- Storage Conditions:
 1. Storage Temperature: $-10^{\circ}\text{C} \sim +40^{\circ}\text{C}$
 2. Relative Humidity: $\leq 75\% \text{RH}$
 3. Keep away from corrosive atmosphere and sunlight.
- Period of Storage: 1 year